

Price List 01.05.2023

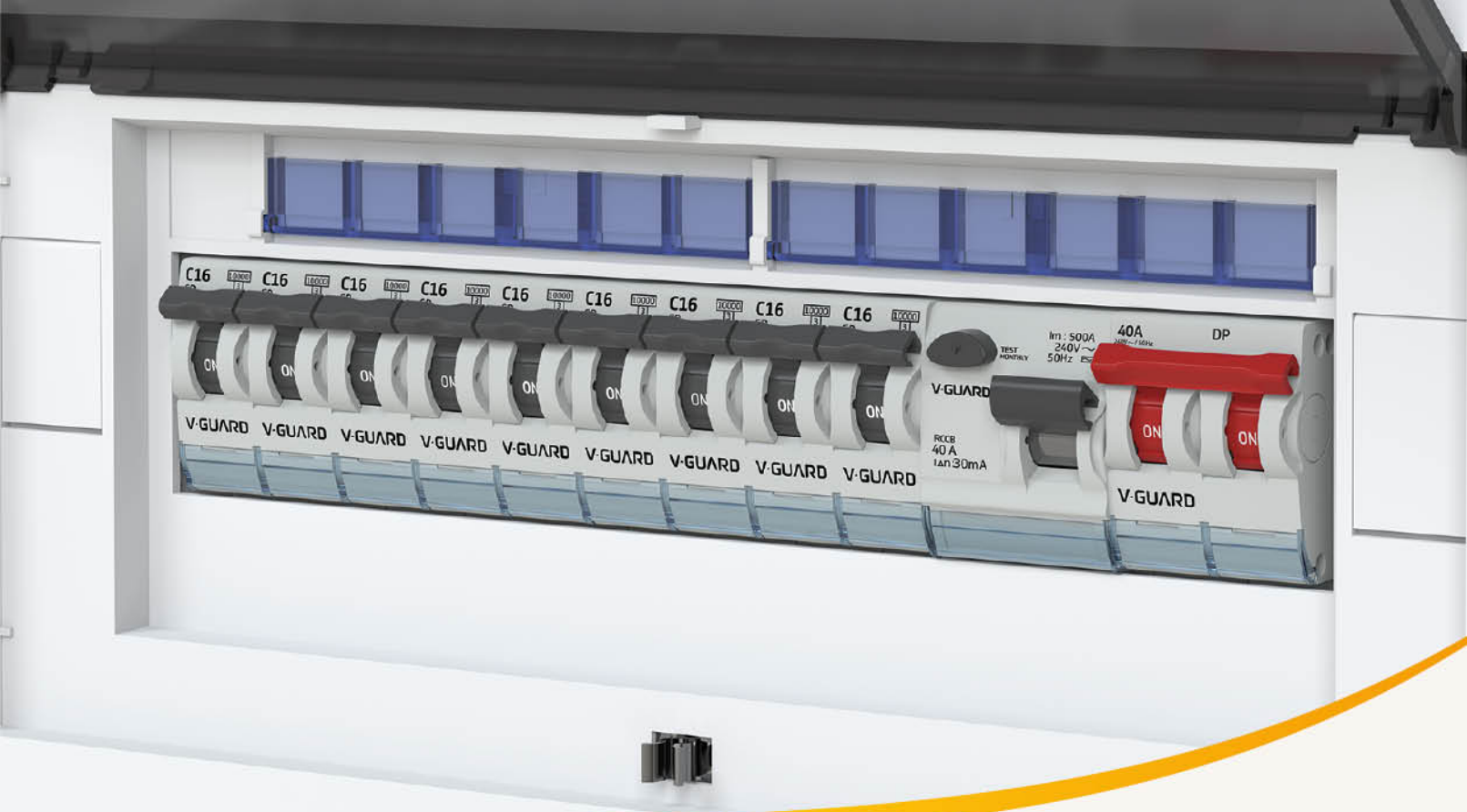

**UNLOCK  
LONG LASTING  
PROTECTION**



## Designed for safety

For over four decades V-Guard lived up to the reputation of making reliable products that were designed to work efficiently and last a lifetime. And now we are taking our next quantum leap. Harnessing the learnings, insights and experience of four decades it will be our endeavour to understand human lives and its relationship with the tools and appliances that he uses. And then to evolve a seamless experience with thoughtful engineered products in our quest to enriching consumer lives.

V-Guard offers a wide range of products built for day to day modern living. Domestic Switch Gears that ensure complete, foolproof safety is just another step towards this vision. V-Guard switch gears are available with more than 10000 authorized dealers and 250 distributors located across 19 states.

They are engineered to detect overcurrents due to both overload and faulty power supply, and interrupt the supply to prevent damage. Designed and developed by V-Guard's ISO 9001:2008 certified and DSIR recognized R&D, these domestic switch gears are made from high-quality components, quality checked at all stages through the manufacturing process and equipped with latest technology and advanced features to deliver superior performance.

## Salient Features



Rugged and Highly reliable Switch Mechanism for long service



State of the art Arc Runner System



DB's are suitable for flush and surface mounting

# Miniature Circuit Breaker (MCB)

Voltage fluctuations should never concern you, that's just why V-Guard brings you a range of Miniature Circuit Breakers. V-Guard's MCBs will make sure all your electrical appliances are safe from any potential voltage problem.

- High quality moulded casing
- Improved and rugged design of operating mechanism
- A state-of-the-art arc runner system

## Bigger Terminal Holders

Equipped with 35 Sq.mm terminal holder, which is best in class and more reliable.

## Operating Lever

Delivers optimum haptic feedback while operating.

## Inscription Window

Helps the end user to detect the faulty circuit path and easily eliminate faulty equipment/appliance.



Conformity with Standards

Bi-Stable Din Clip  
Innovative din clip delivers convenience at peak.

## SINGLE POLE | 10 kA - B TYPE

NEW



Rating (A)	Model	Code
6	MCB 6A SP B ELEGNA	3002088
10	MCB 10A SP B ELEGNA	3002087
16	MCB 16A SP B ELEGNA	3002086
20	MCB 20A SP B ELEGNA	3002085
25	MCB 25A SP B ELEGNA	3002084
32	MCB 32A SP B ELEGNA	3002083

Std Pack 12 Number | Jumbo Packaging 144 Number | # MRP Per Number  
HSN Code: 8536

## SINGLE POLE | 10 kA - C TYPE

NEW



Rating (A)	Model	Code
6	MCB 6A SP C ELEGNA	3002082
10	MCB 10A SP C ELEGNA	3002081
16	MCB 16A SP C ELEGNA	3002080
20	MCB 20A SP C ELEGNA	3002079
25	MCB 25A SP C ELEGNA	3002078
32	MCB 32A SP C ELEGNA	3002077
40	MCB 40A SP C ELEGNA	3002076
63	MCB 63A SP C ELEGNA	3002075

Std Pack 12 Number | Jumbo Packaging 144 Number | # MRP Per Number  
HSN Code: 8536

## SINGLE POLE + NEUTRAL | 10 kA - C TYPE

NEW



Rating (A)	Model	Code
6	MCB 6A SPN C ELEGNA	3002257
10	MCB 10A SPN C ELEGNA	3002074
16	MCB 16A SPN C ELEGNA	3002073
20	MCB 20A SPN C ELEGNA	3002072
25	MCB 25A SPN C ELEGNA	3002071
32	MCB 32A SPN C ELEGNA	3002070
40	MCB 40A SPN C ELEGNA	3002069
63	MCB 63A SPN C ELEGNA	3002068

Std Pack 6 Number | Jumbo Packaging 72 Number | # MRP Per Number  
HSN Code: 8536

## DOUBLE POLE | 10 kA - C TYPE

NEW



Rating (A)	Model	Code
6	MCB 6A DP C ELEGNA	3002067
10	MCB 10A DP C ELEGNA	3002066
16	MCB 16A DP C ELEGNA	3002065
20	MCB 20A DP C ELEGNA	3002064
25	MCB 25A DP C ELEGNA	3002063
32	MCB 32A DP C ELEGNA	3002062
40	MCB 40A DP C ELEGNA	3002061
63	MCB 63A DP C ELEGNA	3002060

Std Pack 6 Number | Jumbo Packaging 72 Number | # MRP Per Number  
HSN Code: 8536

## THREE POLE | 10 kA - C TYPE

NEW



Rating (A)	Model	Code
6	MCB 6A TP C ELEGNA	3002059
10	MCB 10A TP C ELEGNA	3002058
16	MCB 16A TP C ELEGNA	3002057
20	MCB 20A TP C ELEGNA	3002056
25	MCB 25A TP C ELEGNA	3002055
32	MCB 32A TP C ELEGNA	3002054
40	MCB 40A TP C ELEGNA	3002053
63	MCB 63A TP C ELEGNA	3002052

Std Pack 4 Number | Jumbo Packaging 48 Number | # MRP Per Number  
HSN Code: 8536

## THREE POLE + NEUTRAL | 10 kA - C TYPE

NEW



Rating (A)	Model	Code
6	MCB 6A TPN C ELEGNA	3002278
10	MCB 10A TPN C ELEGNA	3002051
16	MCB 16A TPN C ELEGNA	3002050
20	MCB 20A TPN C ELEGNA	3002049
25	MCB 25A TPN C ELEGNA	3002048
32	MCB 32A TPN C ELEGNA	3002047
40	MCB 40A TPN C ELEGNA	3002046
63	MCB 63A TPN C ELEGNA	3002045

Std Pack 3 Number | Jumbo Packaging 36 Number | # MRP Per Number  
HSN Code: 8536

## FOUR POLE | 10 kA - C TYPE

NEW



Rating (A)	Model	Code
6	MCB 6A FP C ELEGNA	3002044
10	MCB 10A FP C ELEGNA	3002312
16	MCB 16A FP C ELEGNA	3002043
20	MCB 20A FP C ELEGNA	3002042
25	MCB 25A FP C ELEGNA	3002041
32	MCB 32A FP C ELEGNA	3002040
40	MCB 40A FP C ELEGNA	3002039
63	MCB 63A FP C ELEGNA	3002038

Std Pack 3 Number | Jumbo Packaging 36 Number | # MRP Per Number  
HSN Code: 8536

# Isolators

NEW



DOUBLE POLE (DP)		
Rating (A)	Model	Code
40	ISO 40A DP ELEGNA	3002037
63	ISO 63A DP ELEGNA	3002036

Std Pack 6 Number | Jumbo Packaging 72 Number | # MRP Per Number  
 HSN Code: 8536

NEW



TRIPPLE POLE (TP)		
Rating (A)	Model	Code
40	ISO 40A TP ELEGNA	3002035
63	ISO 63A TP ELEGNA	3002034

Std Pack 4 Number | Jumbo Packaging 48 Number | # MRP Per Number  
 HSN Code: 8536

FOUR POLE (FP)		
Rating (A)	Model	Code
40	ISO 40A FP ELEGNA	3002033
63	ISO 63A FP ELEGNA	3002032

Std Pack 3 Number | Jumbo Packaging 36 Number | # MRP Per Number  
 HSN Code: 8536

## PROTECTION DEVICES

# Residual Current Circuit Breaker (RCCB)

## TWO POLE



30mA		
Rating (A)	Model	Code
25	RCCB 25A DP 30mA INVIDIA	3000525
40	RCCB 40A DP 30mA INVIDIA	3000522
63	RCCB 63A DP 30mA INVIDIA	3000519
100mA		
25	RCCB 25A DP 100mA INVIDIA	3000524
40	RCCB 40A DP 100mA INVIDIA	3000521
63	RCCB 63A DP 100mA INVIDIA	3000518
100	RCCB 100A DP 100mA INVIDIA	3003534
300mA		
25	RCCB 25A DP 300mA INVIDIA	3000524
40	RCCB 40A DP 300mA INVIDIA	3000521
63	RCCB 63A DP 300mA INVIDIA	3000518

Std Pack 6 Number | Jumbo packaging 24 Number | # MRP Per Number | HSN Code: 8536  
 RCCB 100A DP 100mA INVIDIA: Std Pack 5 Number | Jumbo packaging 30 Number

## FOUR POLE



IS/IEC 61008-1  
CM/L 0006631772

30mA		
Rating (A)	Model	Code
25	RCCB 25A FP 30mA INVIDIA	3000517
40	RCCB 40A FP 30mA INVIDIA	3000515
63	RCCB 63A FP 30mA INVIDIA	3000512
100mA		
25	RCCB 25A FP 100mA INVIDIA	3000516
40	RCCB 40A FP 100mA INVIDIA	3000514
63	RCCB 63A FP 100mA INVIDIA	3000511
100	RCCB 100A FP 100mA INVIDIA	3003141
300mA		
25	RCCB 25A FP 300mA INVIDIA	3001441
40	RCCB 40A FP 300mA INVIDIA	3000513
63	RCCB 63A FP 300mA INVIDIA	3000510

Std Pack 3 Number | Jumbo packaging 12 Number | # MRP Per Number | HSN Code: 8536  
RCCB 100A FP 100mA INVIDIA: Std Pack 3 Number | Jumbo packaging 18 Number

## Automatic Changeover with Current Limiter (ACCL)



A changeover device transfers the load from main power supply to the generator automatically upon failure of the main power supply. It also functions as a load limiter monitoring the generator's power supply to decrease strain on the generator.

Rating (A)	Model	Code
0.5	ACCL 0.5A SPN	1505095
1	ACCL 1A SPN	1505096
1.5	ACCL 1.5A SPN	1505097
2.5	ACCL 2.5A SPN	1505098
3	ACCL 3A SPN	1505099
4	ACCL 4A SPN	1505100
5	ACCL 5A SPN	1505101
6	ACCL 6A SPN	1505102

Std Pack 18 Number |  
HSN Code: 8536

Rating (A)	Model	Code
8	ACCL 8A SPN	1505103
9	ACCL 9A SPN	1505104
10	ACCL 10A SPN	1505105
15	ACCL 15A SPN	1505106
20	ACCL 20A SPN	1505107
25	ACCL 25A SPN	1505108
30	ACCL 30A SPN	1505109

## DC MCB DOUBLE POLE | 10 kA - C TYPE



Rating (A)	Model	Code
16	MCB 16A C 500V DC	3001395

Std Pack 6 Number | Jumbo packaging 72 Number | # MRP Per Number  
 HSN Code: 8536

## Fuse Holder

NEW



The purpose of the V-Guard PV fuse family is to protect photovoltaic modules, strings, or arrays, and the cables that link them, against reverse over-current and short circuits and to reduce safety risks.

- High breaking Capacity: for faults up to 20 kA.
- High reliability: The fuse characteristics do not degrade with the passage of time.
- Enhanced system longevity through durable construction.

Rating	Model	Code	Std. Packing
16A	FUSE & HOLDER 16A 1000V DC INVIDIA	3006396	12 NUMBER
32A	FUSE & HOLDER 32A 1000V DC INVIDIA	3003499	12 NUMBER

# MRP Per Number | HSN Code: 8536

## SPD

NEW



V-Guard SPDs introduced safety for the major components like inverters, arrays, equipment in combiner boxes, and communications system from overvoltage caused by indirect lightning strikes and switching surges. Both AC and DC side of the inverter and other critical component should be equipped with surge protection.

- Tested and Certified by NABL.
- High operating voltages 600Vdc/320Vac.
- High Discharge Current: maximum discharge current I<sub>max</sub>: 40kA.

Rating	Model	Code	Std. Packing
600V DC	SPD 2P 600V DC INVIDIA	3003500	6 NUMBER

# MRP Per Number | HSN Code: 8536

Rating	Model	Code	Std. Packing
320V AC	SPD 2P 320V AC INVIDIA	3003501	6 NUMBER

# MRP Per Number | HSN Code: 8536



# Miniature Change Over Switch (MCOS)

## DOUBLE POLE



Rating (A)	Model	Code
25	MCOS 25A DP 2W	3002725
40	MCOS 40A DP 2W	3002729
63	MCOS 63A DP 2W	3002731

Std Pack 6 Number | Jumbo packaging 36 Number | # MRP Per Number  
 HSN Code: 8536

## FOUR POLE



Rating (A)	Model	Code
25	MCOS 25A FP 2W	3002726
40	MCOS 40A FP 2W	3002730
63	MCOS 63A FP 2W	3002732

Std Pack 3 Number | Jumbo packaging 36 Number | # MRP Per Number  
 HSN Code: 8536

# Phase Selector Rotary Switch



It consists of three (single phase) change over switches, each connected to one of the three phases. The single phase loads are distributed over the three outgoing phase connections. It helps to fight the common problem of phase cut in a three phase connection having single phase loads.

Rating (A)	Model	Code
40	ROTARY SWITCH 1P 3W OFF 40A	1505782
63	ROTARY SWITCH 1P 3W OFF 63A	1505789

Std Pack 10 Number | # MRP Per Number  
 HSN Code: 8536

# MCCB

V-Guard is taking your safety to the next level with its new range of MCCBs. It comes with the following features:

- Range from 63A to 160A (3P/4P).
- 4P with 100% neutral protection.
- Ics = 100% of Icu.
- Double break contact system for high breaking capacity till 25kA.
- Current limiting design for faster arc quenching.
- Conformance to IS/IEC 60947-2.
- Positive isolation to ensure safety.
- Double insulation for enhanced safety.
- No Load-Line Bias.
- Thermal magnetic release: Variable thermal setting (0.8-1 x rated current)  
Fixed magnetic setting (10 x rated current)
- ON-OFF-TRIP Indication.

## THREE POLE



3 POLE		
Rating (A)	Model	Code
63	MCCB 63A 25KA TP F3 INVIDIA	3003174
100	MCCB 100A 25KA TP F3 INVIDIA	3003173
125	MCCB 125A 25KA TP F3 INVIDIA	3003172
160	MCCB 160A 25KA TP F3 INVIDIA	3003171

Jumbo packaging 16 Number | # MRP Per Number  
HSN Code: 8536

## FOUR POLE



4 POLE		
Rating (A)	Model	Code
63	MCCB 63A 25KA FP F3 INVIDIA	3003170
100	MCCB 100A 25KA FP F3 INVIDIA	3003169
125	MCCB 125A 25KA FP F3 INVIDIA	3003143
160	MCCB 160A 25KA FP F3 INVIDIA	3003142

Jumbo packaging 12 Number | # MRP Per Number  
HSN Code: 8536

# Industrial Plug and Socket

Industrial Plug & Socket is a product which is used for the distribution of power supply in such a safe manner. It is primarily intended for industrial use, either indoors or outdoors. Also we can use these accessories on building sites and for agricultural, commercial and domestic applications.

## MOBILE PLUG



Rating	Poles	Model	Code	Std. Packing
16A	2P+E	PS SPNE 16A IP44 6H MP	1505154	48 NUMBER
63A	3P+N+E	PS TPNE 63A IP67 6H MP	1505155	6 NUMBER

# MRP Per Number  
HSN Code: 8536

## MOBILE CONNECTOR



Rating	Poles	Model	Code	Std. Packing
16A	2P+E	PS SPNE 16A IP44 6H MC	1505156	36 NUMBER
63A	3P+N+E	PS TPNE 63A IP67 6H MC	1505157	6 NUMBER

# MRP Per Number  
HSN Code: 8536

## WALL MOUNTED SOCKET



Rating	Poles	Model	Code	Std. Packing
16A	2P+E	PS SPNE 16A IP44 6H WMS	1505159	16 NUMBER

# MRP Per Number  
HSN Code: 8536

## FLANGED PANEL SOCKET



Rating	Poles	Model	Code	Std. Packing
63A	3P+N+E	PS TPNE 63A IP67 6H FPSI	1505158	12 NUMBER

# MRP Per Number  
HSN Code: 8536

## Modular plug and socket

NEW



Rating	Model	Code	Std. Packing
16A	DB 16A SP MODULAR PLUG SOCKET INVIDIA	3001237	10 NUMBER

# MRP Per Number | HSN Code: 8536

## Mini MCB DP with Enclosure - Smartstart



Rating	Model	Code	Std. Packing
32A	SMARTSTART 32A DP C	3001341	25 NUMBER

# MRP Per Number | HSN Code: 8536

# Distribution Boards

## INVIDIA

MOST ADVANCED DISTRIBUTION BOARD



MAGNETIC DOOR LOCKING



REMOVABLE PAN ASSEMBLY



REMOVABLE INTERMITTENT DOOR



DETACHABLE GLAND PLATE & RIGID BOX

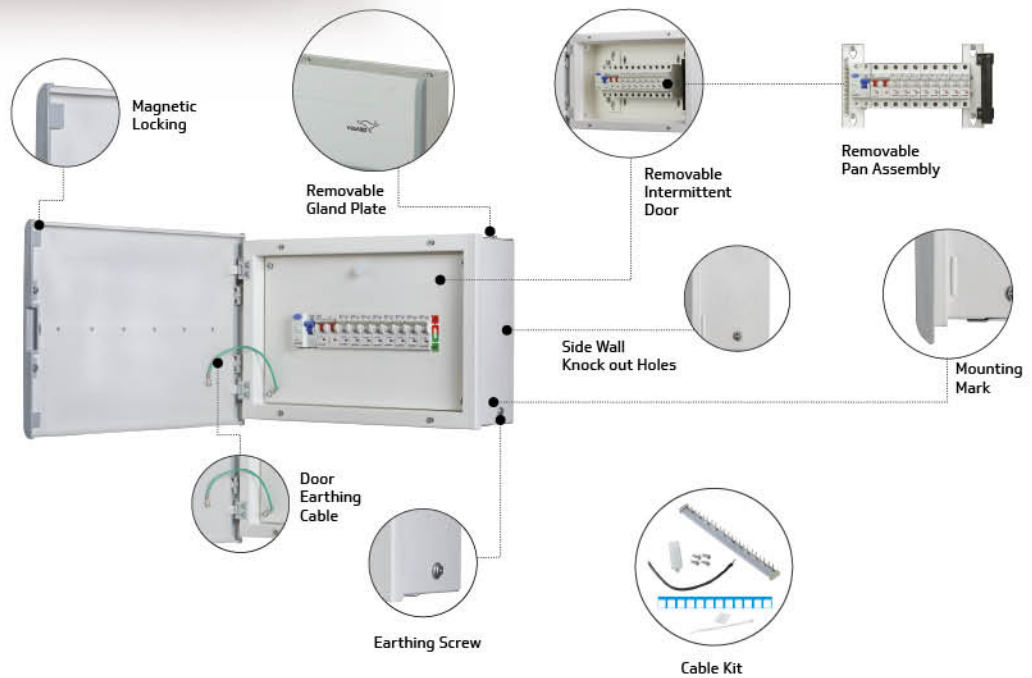

### SPN DOUBLE DOOR DBs



SPN DOUBLE DOOR - COLOUR RAL 9003 SIGNAL WHITE			
No. of ways /IC	Model	Code	Std. Packing
8	DB SPN 8W HORI DD INVIDIA	1504573	4 NUMBER
10	DB SPN 10W HORI DD INVIDIA	1504569	4 NUMBER
12	DB SPN 12W HORI DD INVIDIA	1504570	4 NUMBER
14	DB SPN 14W HORI DD INVIDIA	1504571	1 NUMBER

# MRP Per Number  
HSN Code: 8537

## TPN DOUBLE DOOR DBs



TPN DOUBLE DOOR WITH 8 IC - COLOUR RAL 9003 SIGNAL WHITE			
No. of ways/IC	Model	Code	Std. Packing
4/8	DB TPN 4W HORI DD INVIDIA	1504654	1 NUMBER
6/8	DB TPN 6W HORI DD INVIDIA	1504655	1 NUMBER
8/8	DB TPN 8W HORI DD INVIDIA	1504656	1 NUMBER

# MRP Per Number

HSN Code: 8537

## PHASE SELECTOR VERTICAL DBs

(with rotary switches, duly wired & provision for 8W I/C)



PHASE SELECTOR WITH 40 A SWITCH - COLOUR RAL 9003 SIGNAL WHITE			
No. of ways/IC & Rating(A)	Model	Code	Std. Packing
4/8 & 40A	DB PH SEL 4W 40A V DD INVIDIA	1504647	1 NUMBER
6/8 & 40A	DB PH SEL 6W 40A V DD INVIDIA	1504649	1 NUMBER
8/8 & 40A	DB PH SEL 8W 40A V DD INVIDIA	1504651	1 NUMBER

PHASE SELECTOR WITH 63 A SWITCH - COLOUR RAL 9003 SIGNAL WHITE			
No. of ways/IC & Rating(A)	Model	Code	Std. Packing
4/8 & 63A	DB PH SEL 4W 63A V DD INVIDIA	1504648	1 NUMBER
6/8 & 63A	DB PH SEL 6W 63A V DD INVIDIA	1504650	1 NUMBER
8/8 & 63A	DB PH SEL 8W 63A V DD INVIDIA	1504652	1 NUMBER

PHASE SELECTOR WITH 40A SWITCH - COLOUR RAL 9003 SIGNAL WHITE			
No. of ways/IC & Rating(A)	Model	Code	Std. Packing
4/8 & 40A	DB PH SEL 4W 40A V DD GRPL03	1503789	1 NUMBER
6/8 & 40A	DB PH SEL 6W 40A V DD GRPL03	1503790	1 NUMBER
8/8 & 40A	DB PH SEL 8W 40A V DD GRPL03	1503791	1 NUMBER

PHASE SELECTOR WITH 63A SWITCH - COLOUR RAL 9003 SIGNAL WHITE			
No. of ways/IC & Rating(A)	Model	Code	Std. Packing
4/8 & 63A	DB PH SEL 4W 63A V DD GRPL03	1503792	1 NUMBER
6/8 & 63A	DB PH SEL 6W 63A V DD GRPL03	1503793	1 NUMBER
8/8 & 63A	DB PH SEL 8W 63A V DD GRPL03	1503794	1 NUMBER
12/8 & 63A	DB PH SEL 12W 63A V DD GRPL03	1503974	1 NUMBER

# MRP Per Number

HSN Code: 8537



## VTPN - DOUBLE DOOR VERTICAL DBs



VERTICAL TPN-DOUBLE DOOR - COLOUR RAL 9003 SIGNAL WHITE			
No. of ways /IC	Model	Code	Std. Packing
4/8	DB VTPN 4W V DD INVIDIA	3003462	1 NUMBER
6/8	DB VTPN 6W V DD INVIDIA	3003461	1 NUMBER
8/8	DB VTPN 8W V DD INVIDIA	3003460	1 NUMBER

# MRP Per Number

HSN Code: 8537

## VTPN MCCB INCOMER DBs (160A)



VTPN MCCB INCOMER DBs 160A - COLOUR RAL 9003 SIGNAL WHITE			
No. of ways/IC & Rating(A)	Model	Code	Std. Packing
4/160A	DB VTPN 4W 160A V DD MCCB IC INVIDIA	3000497	1 NUMBER
6/160A	DB VTPN 6W 160A V DD MCCB IC INVIDIA	3000495	1 NUMBER
8/160A	DB VTPN 8W 160A V DD MCCB IC INVIDIA	3000491	1 NUMBER
12/160A	DB VTPN 12W 160A V DD MCCB IC INVIDIA	3000650	1 NUMBER

# MRP Per Number

HSN Code: 8537

## MCCB ENCLOSURE



VTPN MCCB INCOMER DBs 160A - COLOUR RAL 9003 SIGNAL WHITE			
No. of ways/IC & Rating(A)	Model	Code	Std. Packing
160A	DB MCCB ENCLOSURE 160A INVIDIA	3001576	1 NUMBER

# MRP Per Number

HSN Code: 8537

## SEVEN SEGMENT DBs



SEVEN SEGMENT DBs WITH 8 IC - COLOUR RAL 9003 SIGNAL WHITE			
No. of ways/IC	Model	Code	Std. Packing
4/4/8	DB 7 SEG 4W 4/8 V DD INVIDIA	1504904	1 NUMBER
6/4/8	DB 7 SEG 6W 4/8 V DD INVIDIA	1504905	1 NUMBER
8/4/8	DB 7 SEG 8W 4/8 V DD INVIDIA	1504906	1 NUMBER

# MRP Per Number

HSN Code: 8537

# INVIDIA SPN ACRYLIC DOOR DBs



REVERSIBLE OUTER  
TRANSPARENT  
DOOR



FABRICATED OUT OF  
FLAME RETARDANT  
PC MATERIAL



REMOVABLE  
INTERMITTENT  
DOOR

## SPN INVIDIA FR AD DOUBLE DOOR DBs (With Fire Retardant box and door)



SPN FR ACRYLIC DOOR DBs			
No. of ways/IC	Model	Code	Std. Packing
4/6	DB SPN 4/6W HORI FR AD INVIDIA	1505220	10 NUMBER
7/9	DB SPN 7/9W HORI FR AD INVIDIA	1505221	8 NUMBER
10/12	DB SPN 10/12W HORI FR AD INVIDIA	1505222	5 NUMBER
14/16	DB SPN 14/16W HORI FR AD INVIDIA	1505223	5 NUMBER
17/19	DB SPN 17/19W HORI FR AD INVIDIA	1505224	5 NUMBER

# MRP Per Number

HSN Code: 8537

## SWITCH FUSE UNIT



SWITCH FUSE UNIT - COLOUR RAL 9003 SIGNAL WHITE				
Category	Rating (A)	Model	Code	Std. Packing
DP	16A	SFU 16A 240V DP INVIDIA	1505951	10 NUMBER
	32A	SFU 32A 240V DP INVIDIA	1505949	10 NUMBER
TPN	32A	SFU 32A 415V TPN INVIDIA	3001013	4 NUMBER
	63A	SFU 63A 415V TPN INVIDIA	3001012	2 NUMBER
	100A	SFU 100A 415V TPN INVIDIA	3001011	1 NUMBER

# MRP Per Number

HSN Code: 8537

# ELEGNA

EXTRAORDINARY DISTRIBUTION BOARD



MAGNETIC DOOR LOCKING



REVERSIBLE OUTER MAGNETIC DOOR

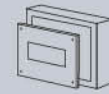

REMOVABLE INTERMITTENT DOOR



DETACHABLE GLAND PLATE & RIGID BOX



Magnetic Locking



Isolated N-Link for Inverter connection



Double line insertion mark



Removable Intermittent Door

Removable gland plate

Cement protection mask

## SPN DOUBLE DOOR DBs

NEW



SPN DOUBLE DOOR - COLOUR RAL 9003 SIGNAL WHITE			
No. of ways/IC	Model	Code	Std. Packing
4	DB SPN 4W HORI DD ELEGNA	3002288	6 NUMBER
6	DB SPN 6W HORI DD ELEGNA	3002287	6 NUMBER
8	DB SPN 8W HORI DD ELEGNA	3002286	6 NUMBER
10	DB SPN 10W HORI DD ELEGNA	3002285	6 NUMBER
12	DB SPN 12W HORI DD ELEGNA	3002284	4 NUMBER
16	DB SPN 16W HORI DD ELEGNA	3002282	4 NUMBER

# MRP Per Number  
HSN Code: 8537





## TPN DOUBLE DOOR DBs

NEW



TPN DOUBLE DOOR - COLOUR RAL 9003 SIGNAL WHITE			
No. of ways	Model	Code	Std. Packing
4/8	DB TPN 4W HORI DD ELEGNA	3002281	1 NUMBER
6/8	DB TPN 6W HORI DD ELEGNA	3002280	1 NUMBER
8/8	DB TPN 8W HORI DD ELEGNA	3002279	1 NUMBER
12/8	DB TPN 12W HORI DD ELEGNA	3003345	1 NUMBER

# MRP Per Number  
HSN Code: 8537

## PHASE SELECTOR ENCLOSURE DBs



PHASE SELECTOR ENCLOSURE DBs - COLOUR RAL 9003 SIGNAL WHITE			
Rating(A)	Model	Code	Std. Packing
40A	PH SEL ENCLOSURE 40A GRVE01	1503858	1 NUMBER
63A	PH SEL ENCLOSURE 63A GRVE01	1503859	1 NUMBER

# MRP Per Number  
HSN Code: 8537



## ELEGNA SPN ACRYLIC DOOR DBs



FABRICATED OUT OF  
FLAME RETARDANT  
PC & ABS MATERIAL



PUSH BUTTON  
DOOR LOCKING



ADJUSTABLE  
DIN RAIL

### SPN ELEGNA FR AD SINGLE DOOR DBs (With Fire Retardant box and door)



SPN FR ACRYLIC DOOR DBs			
No. of ways/IC	Model	Code	Std. Packing
4/7	DB SPN 4/7W HORI FR AD ELEGNA	1505417	10 NUMBER
8/10	DB SPN 8/10W HORI FR AD ELEGNA	1505418	10 NUMBER
11/13	DB SPN 11/13W HORI FR AD ELEGNA	1505419	5 NUMBER
14/16	DB SPN 14/16W HORI FR AD ELEGNA	1505420	5 NUMBER
17/20	DB SPN 17/20W HORI FR AD ELEGNA	1505421	5 NUMBER

# MRP Per Number  
HSN Code: 8537

# CLASSO

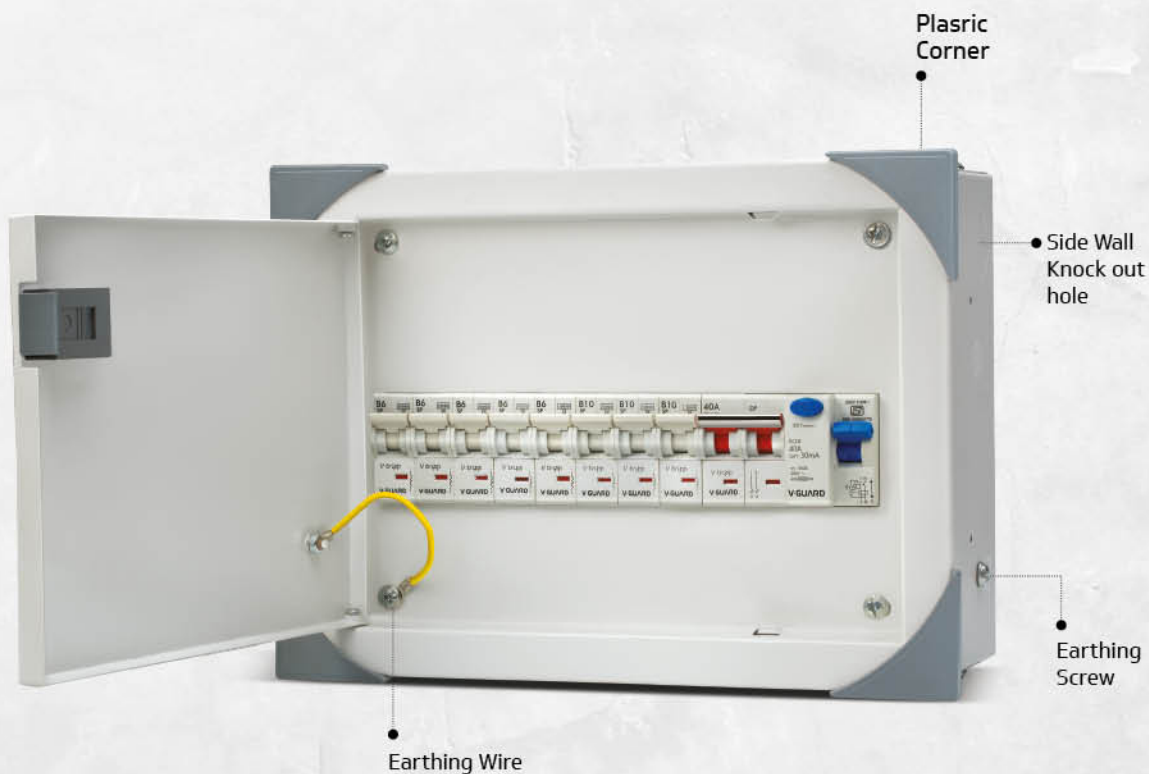

## SPN DOUBLE DOOR DBs



SPN DOUBLE DOOR - COLOUR RAL 9003 SIGNAL WHITE			
No. of ways	Model	Code	Std. Packing
4	DB SPN 4W HORI DD CLASSO	1505822	6 NUMBER
6	DB SPN 6W HORI DD CLASSO	1505821	6 NUMBER
8	DB SPN 8W HORI DD CLASSO	1505820	6 NUMBER
10	DB SPN 10W HORI DD CLASSO	1505819	4 NUMBER
12	DB SPN 12W HORI DD CLASSO	1505818	4 NUMBER
16	DB SPN 16W HORI DD CLASSO	1505823	4 NUMBER

# MRP Per Number  
 HSN Code: 8537

## TPN DOUBLE DOOR DBs



TPN DOUBLE DOOR - COLOUR RAL 9003 SIGNAL WHITE			
No. of ways	Model	Code	Std. Packing
4/8	DB TPN 4W HORI DD CLASSO	1506004	2 NUMBER
6/8	DB TPN 6W HORI DD CLASSO	1506003	2 NUMBER
8/8	DB TPN 8W HORI DD CLASSO	1506002	2 NUMBER

# MRP Per Number  
HSN Code: 8537

## PHASE SELECTOR HORIZONTAL DBs (with rotary switches, duly wired & provision for 8W I/C)



PHASE SELECTOR WITH 40A SWITCH - COLOUR RAL 9003 SIGNAL WHITE			
No. of ways /IC & Rating(A)	Model	Code	Std. Packing
4/8 & 40A	DB PH SEL 4W 40A HORI DD CLASSO	1503860	2 NUMBER
6/8 & 40A	DB PH SEL 6W 40A HORI DD CLASSO	1503861	2 NUMBER
8/8 & 40A	DB PH SEL 8W 40A HORI DD CLASSO	1503862	2 NUMBER
HORIZONTAL PHASE SELECTOR WITH 63A SWITCH - COLOUR RAL 9003 SIGNAL WHITE			
4/8 & 63A	DB PH SEL 4W 63A HORI DD CLASSO	1503863	2 NUMBER
6/8 & 63A	DB PH SEL 6W 63A HORI DD CLASSO	1503864	2 NUMBER
8/8 & 63A	DB PH SEL 8W 63A HORI DD CLASSO	1503865	2 NUMBER

# MRP Per Number  
HSN Code: 8537

## SPN - SINGLE DOOR DBs



SPN SINGLE DOOR - COLOUR RAL 9003 SIGNAL WHITE			
No. of ways	Model	Code	Std. Packing
4	DB SPN 4W HORI SD CLASSO	1500720	1 NUMBER
6	DB SPN 6W HORI SD CLASSO	1500726	1 NUMBER
8	DB SPN 8W HORI SD CLASSO	1500733	1 NUMBER
12	DB SPN 12W HORI SD CLASSO	1500740	1 NUMBER
16	DB SPN 16W HORI SD CLASSO	1500744	1 NUMBER

# MRP Per Number  
HSN Code: 8537

## MCB ENCLOSURES DBs



MCB ENCLOSURE - COLOUR RAL 9003 SIGNAL WHITE			
No. of ways	Model	Code	Std. Packing
2	DB MCB ENCLOSURE 2W CLASSO	1500758	40 NUMBER
4	DB MCB ENCLOSURE 4W CLASSO	1500756	30 NUMBER

# MRP Per Number  
HSN Code: 8537

## SPN ACRYLIC DOOR DBs (Metal box)



SPN ACRYLIC DOOR - COLOUR RAL 9003 SIGNAL WHITE			
No. of ways	Model	Code	Std. Packing
2/4	DB SPN 2/4W HORI AD CLASSO	1504516	12 NUMBER
6/8	DB SPN 6/8W HORI AD CLASSO	1504527	12 NUMBER
12/14	DB SPN 12/14W HORI AD CLASSO	1504525	6 NUMBER
16/18	DB SPN 16/18W HORI AD CLASSO	1504514	6 NUMBER

# MRP Per Number

HSN Code: 8537

## AC PLUG & SOCKET DBs



AC PLUG & SOCKET - COLOUR RAL 9003 SIGNAL WHITE			
Rating (A)	Model	Code	Std. Packing
20	DB SPN 20A PLUG SOCKET CLASSO	1504518	30 NUMBER

AC PLUG - COLOUR RAL 9003 SIGNAL WHITE			
Rating(A)	Model	Code	Std. Packing
30	DB TPN 30A PLUG SOCKET GRPL01	1500755	1 NUMBER



AC SOCKET - COLOUR RAL 9003 SIGNAL WHITE			
Rating(A)	Model	Code	Std. Packing
20	SPN 20A METAL CLAD PLUG	1503813	10 NUMBER
20	SPN 20A METAL CLAD SOCKET	1503817	10 NUMBER
30	TPN 30A METAL CLAD PLUG	1503816	10 NUMBER
30	TPN 30A METAL CLAD SOCKET	1503820	10 NUMBER

# MRP Per Number

HSN Code: 8537

## PROTECTION DEVICES

# Residual Current Circuit Breaker (RCCB)

### TWO POLE



30mA		
Rating (A)	Model	Code
25	RCCB 25A DP 30mA	1501489
40	RCCB 40A DP 30mA	3000365
63	RCCB 63A DP 30mA	1501009
100mA		
25	RCCB 25A DP 100mA	1501487
40	RCCB 40A DP 100mA	3000367
63	RCCB 63A DP 100mA	1501501
300mA		
25	RCCB 25A DP 300mA	1501488
40	RCCB 40A DP 300mA	1501500
63	RCCB 63A DP 300mA	1501502

Std Pack 6 Number | Jumbo Packaging 72 Number | # MRP Per Number

HSN Code: 8536

AVAILABLE TILL  
STOCK LAST

### FOUR POLE



30mA		
Rating (A)	Model	Code
25	RCCB 25A FP 30mA	1501492
40	RCCB 40A FP 30mA	1500714
63	RCCB 63A DP 30mA	1500710
100	RCCB 100A FP 30mA	1501481
100mA		
25	RCCB 25A FP 100mA	1501490
40	RCCB 40A FP 100mA	1500715
63	RCCB 63A FP 100mA	1500711
100	RCCB 100A FP 100mA	1501479
300mA		
25	RCCB 25A FP 300mA	1501491
40	RCCB 40A FP 300mA	1500716
63	RCCB 63A FP 300mA	1500712
100	RCCB 100A FP 300mA	1501480

Std Pack 3 Number | Jumbo Packaging 36 Number | # MRP Per Number

HSN Code: 8536

AVAILABLE TILL  
STOCK LAST

### SPN - DOUBLE DOOR DBs



SPN DOUBLE DOOR - COLOUR RAL 9003 SIGNAL WHITE			
No. of ways	Model	Code	Std. Packing
4	DB SPN 4W HORI DD GRPL01/ GRVE01	1501010/ 1503985	1 NUMBER
6	DB SPN 6W HORI DD GRPL01/ GRVE01	1501011/ 1503986	4 NUMBER
8	DB SPN 8W HORI DD GRPL01/ GRVE01	1500734/ 1503987	4 NUMBER
10	DB SPN 10W HORI DD GRPL01/ GRVE01	1504737/ 1505276	4 NUMBER
12	DB SPN 12W HORI DD GRPL01/ GRVE01	1500741/ 1503988	4 NUMBER
16	DB SPN 16W HORI DD GRPL01/ GRVE01	1500745/ 1503989	1 NUMBER

# MRP Per Number

HSN Code: 8537

AVAILABLE TILL  
STOCK LAST

## TPN - DOUBLE DOOR VERTICAL DBs



AVAILABLE TILL  
STOCK LAST

VERTICAL TPN-DOUBLE DOOR - COLOUR RAL 9003 SIGNAL WHITE			
No. of ways /IC	Model	Code	Std. Packing
4/8	DB TPN 4W V DD GRPL01	1502347	1 NUMBER
6/8	DB TPN 6W V DD GRPL01	1502348	1 NUMBER
8/8	DB TPN 8W V DD GRPL01	1502349	1 NUMBER

# MRP Per Number

HSN Code: 8537

## TPN - DOUBLE DOOR DBs



TPN DOUBLE DOOR - COLOUR RAL 9003 SIGNAL WHITE			
No. of ways/IC	Model	Code	Std. Packing
4/8	DB TPN 4W HORI DD GRPL01	1500722	1 NUMBER
6/8	DB TPN 6W HORI DD GRPL01	1500728	1 NUMBER
8/8	DB TPN 8W HORI DD GRPL01	1500736	1 NUMBER
12/8	DB TPN 12W HORI DD GRPL01	1501012	1 NUMBER

# MRP Per Number

HSN Code: 8537

AVAILABLE TILL  
STOCK LAST

## PHASE SELECTOR VERTICAL DBs

(with rotary switches, duly wired & provision for 8W I/C)



PHASE SELECTOR WITH 40A SWITCH - COLOUR RAL 9003 SIGNAL WHITE			
No. of ways/IC & Rating(A)	Model	Code	Std. Packing
4/8 & 40A	DB PH SEL 4W 40A V DD GRVE01	1501996	1 NUMBER
6/8 & 40A	DB PH SEL 6W 40A V DD GRVE01	1501997	1 NUMBER
8/8 & 40A	DB PH SEL 8W 40A V DD GRVE01	1501998	1 NUMBER
PHASE SELECTOR WITH 63A SWITCH - COLOUR RAL 9003 SIGNAL WHITE			
4/8 & 63A	DB PH SEL 4W 63A V DD GRVE01	1501999	1 NUMBER
6/8 & 63A	DB PH SEL 6W 63A V DD GRVE01	1502000	1 NUMBER
8/8 & 63A	DB PH SEL 8W 63A V DD GRVE01	1502001	1 NUMBER

# MRP Per Number

HSN Code: 8537

AVAILABLE TILL  
STOCK LAST

Note: MRP shown in the price list includes all taxes.

# SPECIFICATION CHART

## INVIDIA

Category	Colour	No. of ways	Model	SAP Code	Dimensions in cm		
					A (Height)	B (Width)	C (Depth)
INVIDIA SPN DBs	RAL - 9003 Signal white	8	DB SPN 8W HORI DD INVIDIA	1504573	22.8	29.5	9
		10	DB SPN 10W HORI DD INVIDIA	1504569	22.8	33.1	9
		12	DB SPN 12W HORI DD INVIDIA	1504570	22.8	36.7	9
		14	DB SPN 14W HORI DD INVIDIA	1504571	22.8	40.3	9
INVIDIA TPN DBs	RAL - 9003 Signal white	4	DB TPN 4W HORI DD INVIDIA	1504654	37	41.1	8.3
		6	DB TPN 6W HORI DD INVIDIA	1504655	37	44.7	8.3
		8	DB TPN 8W HORI DD INVIDIA	1504656	37	48.3	8.3
INVIDIA Phase selector DBs	RAL - 9003 Signal white	4	DB PH SEL 4W 40A V DD INVIDIA	1504647	56	39.9	9.7
		6	DB PH SEL 6W 40A V DD INVIDIA	1504649	56	43.5	9.7
		8	DB PH SEL 8W 40A V DD INVIDIA	1504651	56	47.1	9.7
		4	DB PH SEL 4W 63A V DD INVIDIA	1504648	56	39.9	9.7
		6	DB PH SEL 6W 63A V DD INVIDIA	1504650	56	43.5	9.7
		8	DB PH SEL 8W 63A V DD INVIDIA	1504652	56	47.1	9.7

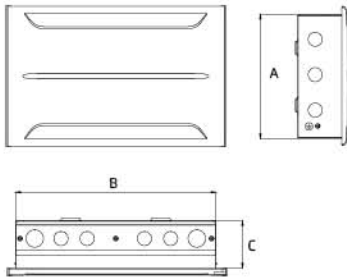

INVIDIA SPN DBs

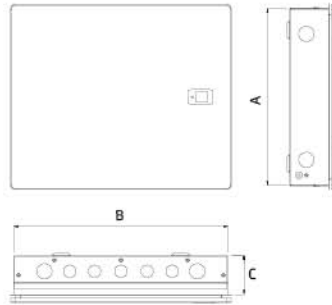

INVIDIA TPN DBs

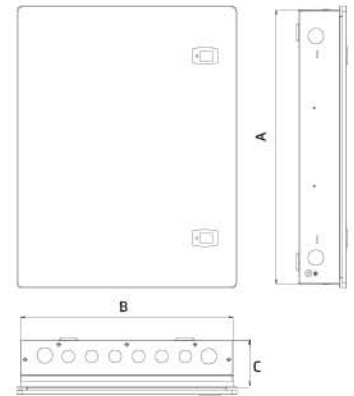

INVIDIA PHASE SELECTOR DBs

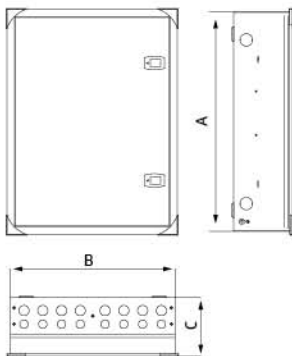

Phase Selector DBs Premium Series

Category	Colour	No. of ways	Model	SAP Code	Dimensions in cm		
					A (Height)	B (Width)	C (Depth)
Phase selector DBs	RAL - 9003 Signal white	4	DB PH SEL 4W 40A V DD GRPL03	1503789	56	42	15
		6	DB PH SEL 6W 40A V DD GRPL03	1503790	56	45.6	15
		8	DB PH SEL 8W 40A V DD GRPL03	1503791	56	49.2	15
		4	DB PH SEL 4W 63A V DD GRPL03	1503792	56	42	15
		6	DB PH SEL 6W 63A V DD GRPL03	1503793	56	45.6	15
		8	DB PH SEL 8W 63A V DD GRPL03	1503794	56	49.2	15
		12	DB PH SEL 12W 63A V DD GRPL03	1503974	56	56.4	15

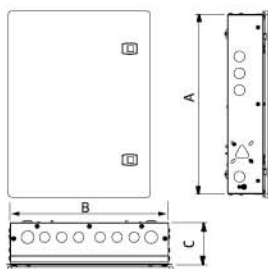

Vertical TPN DBs

Category	Colour	No. of ways	Model	SAP Code	Dimensions in cm		
					A (Height)	B (Width)	C (Depth)
Vertical TPN DBs	RAL - 9003 Signal white	4	DB VTPN 4W V DD INVIDIA	3003462	47.8	40	10.6
		6	DB VTPN 6W V DD INVIDIA	3003461	53.2	40	10.6
		8	DB VTPN 8W V DD INVIDIA	3003460	58.6	40	10.6



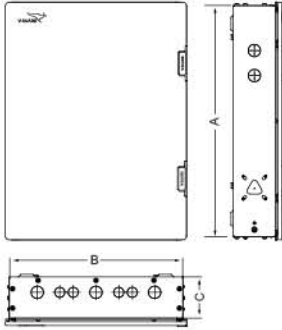

VTPN MCCB Incomer DBs (160A)

Category	Colour	No. of ways	Model	SAP Code	Dimensions in cm		
					A (Height)	B (Width)	C (Depth)
VTPN MCCB Incomer DB	RAL-9003 Signal white	4	DB VTPN 4W 160A V DD MCCB IC INVIDIA	3000497	60	45	11
		6	DB VTPN 6W 160A V DD MCCB IC INVIDIA	3000495	65.4	45	11
		8	DB VTPN 8W 160A V DD MCCB IC INVIDIA	3000491	70.8	45	11
		12	DB VTPN 12W 160A V DD MCCB IC INVIDIA	3000650	81.6	45	11

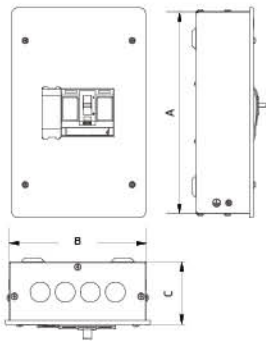

MCCB Enclosure 160A

Category	Colour	No. of ways	Model	SAP Code	Dimensions in cm		
					A (Height)	B (Width)	C (Depth)
MCCB Enclosure	RAL-9003 Signal white	4	MCCB ENCLOSURE 160A INVIDIA	3001576	35.1	21.8	10

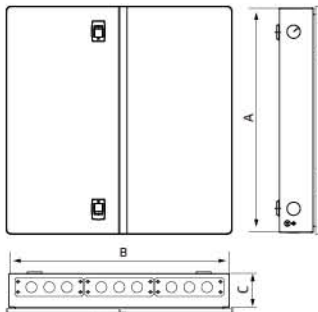

7 Segment DBs

Category	Colour	No. of ways	Model	SAP Code	Dimensions in cm		
					A (Height)	B (Width)	C (Depth)
Seven Segment DBs	RAL-9003 Signal white	4	DB 7SEG 4W 4/8 V DD INVIDIA	1504904	54.2	42.5	8.5
		6	DB 7SEG 6W 4/8 V DD INVIDIA	1504905	54.2	53.3	8.5
		8	DB 7SEG 8W 4/8 V DD INVIDIA	1504906	54.2	64.1	8.5

PPI 4 Tier DBs

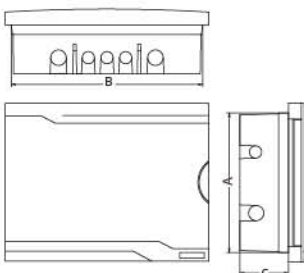

SPN Invidia FR AD DBs

Category	Colour	No. of ways	Model	SAP Code	Dimensions in cm		
					A (Height)	B (Width)	C (Depth)
SPN Invidia FR AD DB	White + Grey	4/6	DB SPN 4/6W HORI FR AD INVIDIA	1505220	23	20.6	8
		7/9	DB SPN 7/9W HORI FR AD INVIDIA	1505221	23	26.0	8
		10/12	DB SPN 10/12W HORI FR AD INVIDIA	1505222	23	31.4	8
		14/16	DB SPN 14/16W HORI FR AD INVIDIA	1505223	23	38.6	8
		17/19	DB SPN 17/19W HORI FR AD INVIDIA	1505224	23	44.0	8

## ELEGNA

Category	Colour	No. of ways	Model	SAP Code	Dimensions in cm		
					A (Height)	B (Width)	C (Depth)
SPN Double Door DBs	RAL-9003 Signal white	4	DB SPN 4W HORI DD ELEGNA	3002288	22.5	14	9
		6	DB SPN 6W HORI DD ELEGNA	3002287	22.5	17.6	9
		8	DB SPN 8W HORI DD ELEGNA	3002286	22.5	21.2	9
		10	DB SPN 10W HORI DD ELEGNA	3002285	22.5	24.8	9
		12	DB SPN 12W HORI DD ELEGNA	3002284	22.5	28.4	9
		16	DB SPN 16W HORI DD ELEGNA	3002282	22.5	36.4	9
TPN Double Door DBs	RAL-9003 Signal white	4	DB TPN 4W HORI DD ELEGNA	3002281	38.4	33	9
		6	DB TPN 6W HORI DD ELEGNA	3002280	38.4	36.6	9
		8	DB TPN 8W HORI DD ELEGNA	3002279	38.4	40.2	9

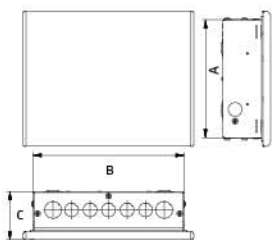

SPN Double Door DBs

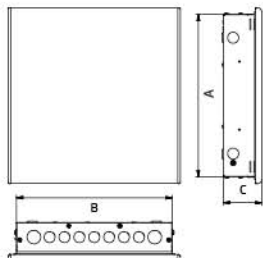

TPN Double Door DBs

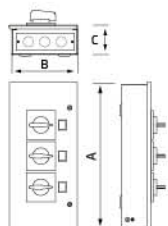

Phase Selector Enclosure

Category	Colour	Rating	Model	SAP Code	Dimensions in cm		
					A (Height)	B (Width)	C (Depth)
Phase Selector Enclosure	RAL-9003 Signal white	40 A	PH SEL ENCLOSURE 40A GRVE01	1503858	38.6	17.5	8.2
		63 A	PH SEL ENCLOSURE 63A GRVE01	1503859	43.7	20.0	9.0

Category	Colour	No. of ways	Model	SAP Code	Dimensions in cm		
					A (Height)	B (Width)	C (Depth)
SPN Plug & Socket DBs	RAL-9003 Signal white	20 A	DB SPN 20A PLUG SOCKET GRPL01	1500753	15.5	12.4	6
TPN Plug & Socket DBs	RAL-9003 Signal white	20 A	DB TPN 20A PLUG SOCKET GRPL01	1500752	26	11.5	6
		30 A	DB TPN 30A PLUG SOCKET GRPL01	1500755	26	11.5	6

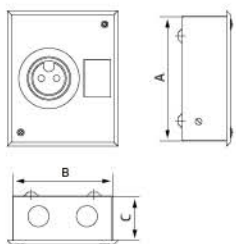

SPN Plug & Socket DBs

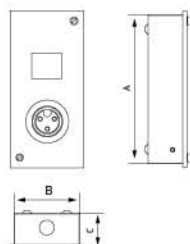

TP AC Plug & Socket DBs

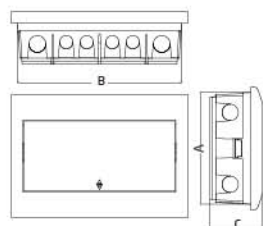

SPN Elegna FR AD DBs

Category	Colour	No. of ways	Model	SAP Code	Dimensions in cm		
					A (Height)	B (Width)	C (Depth)
SPN Elegna FR AD DB	White + Grey	4/7	DB SPN 4/7W HORI FR AD ELEGNA	1505417	22	21.4	8
		8/10	DB SPN 8/10W HORI FR AD ELEGNA	1505418	22	26.8	8
		11/13	DB SPN 11/13W HORI FR AD ELEGNA	1505419	22	32.2	8
		14/16	DB SPN 14/16W HORI FR AD ELEGNA	1505420	22	37.6	8
		17/20	DB SPN 17/20W HORI FR AD ELEGNA	1505421	22	44.8	8

# CLASSO

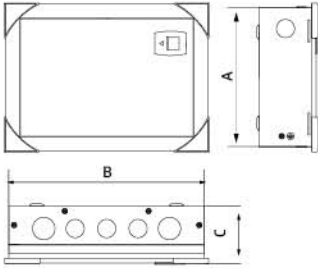

SPN Double Door DBs

Category	Colour	No. of ways	Model	SAP Code	Dimensions in cm		
					A (Height)	B (Width)	C (Depth)
SPN Double Door DBs	RAL-9003 Signal white	4	DB SPN 4W HORI DD CLASSO	1505822	20	13.6	8.2
		6	DB SPN 6W HORI DD CLASSO	1505821	20	17.2	8.2
		8	DB SPN 8W HORI DD CLASSO	1505820	20	20.8	8.2
		10	DB SPN 10W HORI DD CLASSO	1505819	20	24.4	8.2
		12	DB SPN 12W HORI DD CLASSO	1505818	20	28	8.2
		16	DB SPN 16W HORI DD CLASSO	1505823	20	35.2	8.2

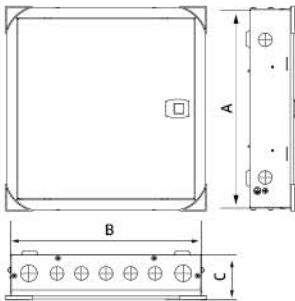

TPN Double Door DBs

Category	Colour	No. of ways	Model	SAP Code	Dimensions in cm		
					A (Height)	B (Width)	C (Depth)
TPN Double Door DBs	RAL-9003 Signal white	4	DB TPN 4W HORI DD CLASSO	1506004	38	33	8.5
		6	DB TPN 6W HORI DD CLASSO	1506003	38	36.6	8.5
		8	DB TPN 8W HORI DD CLASSO	1506002	38	40.2	8.5

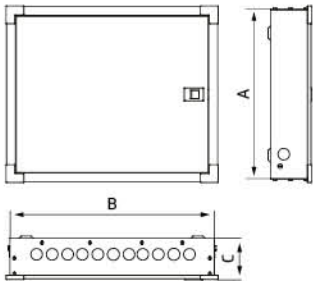

Horizontal Phase Selector DBs

Category	Colour	No. of ways	Model	SAP Code	Dimensions in cm		
					A (Height)	B (Width)	C (Depth)
Phase Selector DBs	RAL-9003 Signal white	4	DB PH SEL 4W 40A HORI DD CLASSO	1503860	42.4	48	11
		6	DB PH SEL 6W 40A HORI DD CLASSO	1503861	42.4	51.5	11
		8	DB PH SEL 8W 40A HORI DD CLASSO	1503862	42.4	55	11
		4	DB PH SEL 4W 63A HORI DD CLASSO	1503863	42.4	48	13.5
		6	DB PH SEL 6W 63A HORI DD CLASSO	1503864	42.4	51.5	13.5
		8	DB PH SEL 8W 63A HORI DD CLASSO	1503865	42.4	55	13.5

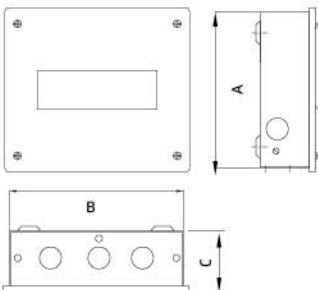

SPN Single Door DBs

Category	Colour	No. of ways	Model	SAP Code	Dimensions in cm		
					A (Height)	B (Width)	C (Depth)
SPN Single Door DBs	RAL-9003 Signal white	4	DB SPN 4W HORI SD CLASSO	1500720	18.3	13.7	6.3
		6	DB SPN 6W HORI SD CLASSO	1503876	18.3	17.1	6.3
		8	DB SPN 8W HORI SD CLASSO	1500733	18.3	20.9	6.3
		12	DB SPN 12W HORI SD CLASSO	1500740	18.3	28.1	6.3
		16	DB SPN 16W HORI SD CLASSO	1500744	18.3	35.3	6.3

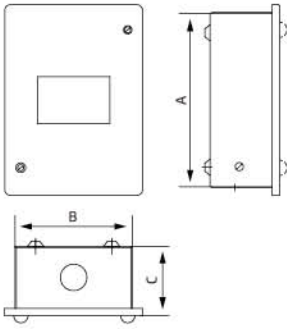

Enclosure DBs

Category	Colour	No. of ways	Model	SAP Code	Dimensions in cm		
					A (Height)	B (Width)	C (Depth)
Enclosure DBs	RAL-9003 Signal white	2	DB MCB ENCLOSURE 2W CLASSO	1500758	16.7	8.3	6
		4	DB MCB ENCLOSURE 4W CLASSO	1500756	16.7	12	6

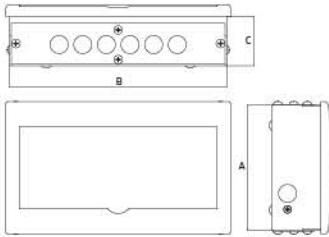

SPN AD DBs

Category	Colour	No. of ways	Model	SAP Code	Dimensions in cm		
					A (Height)	B (Width)	C (Depth)
SPN AD DB	RAL-9003 Signal white	2/4	DB SPN 2/4W HORI AD CLASSO	1504516	17.5	12.6	7.1
		6/8	DB SPN 6/8W HORI AD CLASSO	1504527	17.5	19.8	7.1
		12/14	DB SPN 12/14W HORI AD CLASSO	1504525	17.5	30.8	7.1
		16/18	DB SPN 16/18W HORI AD CLASSO	1504514	17.5	37.8	7.1

PANEL CUTOUT

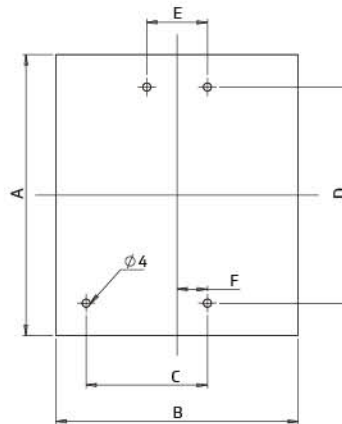
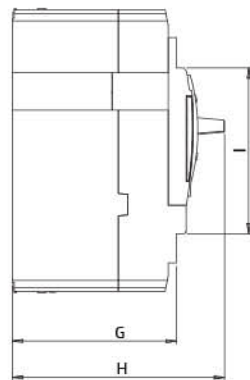
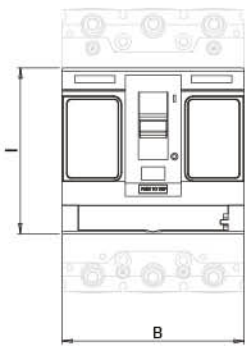

Invidia MCCB

MCCB	A	B	C	D	E	F	G	H	I
3P	139	90	30	107	30	15	82	110	82
4P	139	120	60	107	30	15	82	110	82

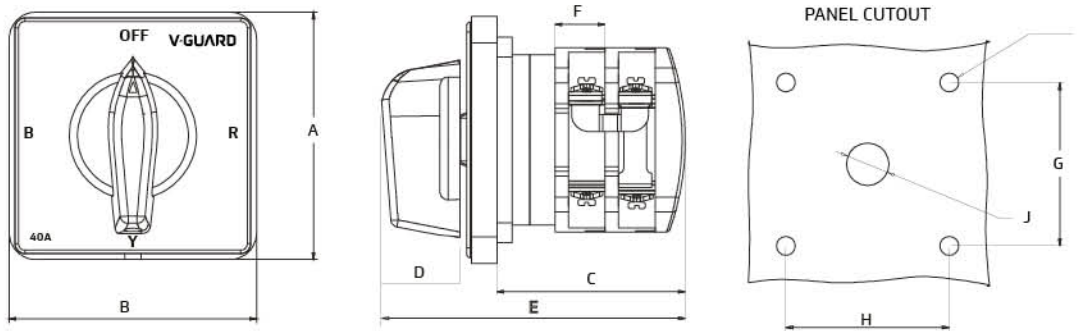

Phase Selector Rotary Switch

### Connection Diagram

For Phase selector Distribution Board

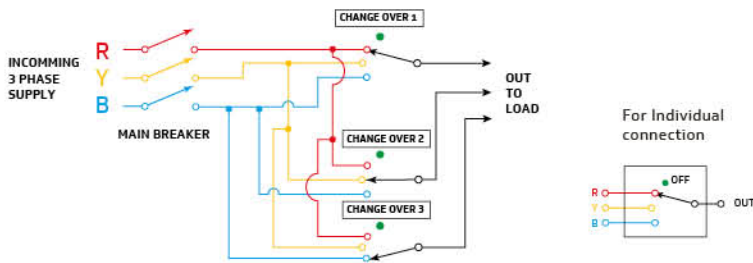

	25A	32A	40A	63A
A	75	75	75	90
B	75	75	75	90
C	57	57	57	70
D	23.4	23.4	23.4	35.5
E	92	92	92	115
F	15	15	15	21
G	48	48	48	68
H	48	48	48	68
I	Ø12.5	Ø12.5	Ø12.5	Ø12.5
J	Ø5.5X4N	Ø5.5X4N	Ø5.5X4N	Ø5.5X4N

All dimensions are in mm

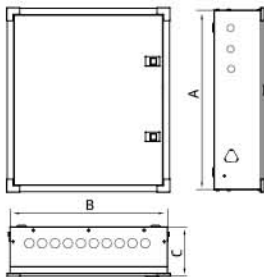

Category	Colour	No. of ways	Model	SAP Code	Dimensions in cm		
					A (Height)	B (Width)	C (Depth)
Vertical TPN DBs	RAL - 9003 Signal white	4	DB TPN 4W V DD GRPL01	1502347	49.9	40	11.8
		6	DB TPN 6W V DD GRPL01	1502348	54.9	40	11.8
		8	DB TPN 8W V DD GRPL01	1502349	59.7	40	11.8

# NOTE





V-Guard Industries Ltd.,  
Registered Office: 42/962,  
Vennala High School Road,  
Vennala, Kochi - 682028, Kerala.  
Ph: 0484-2005000, 4335000  
[www.vguard.in](http://www.vguard.in)



V-Guard Care  
1800 103 1300 (Toll Free)  
1860 180 3000 (Charges Apply)  
[customercare@vguard.in](mailto:customercare@vguard.in)  
© 9633503333

[www.vguard.in/home/customer-care](http://www.vguard.in/home/customer-care)  
CIN: L31200KL1996PLC010010